

DS-2DF8A442IXG-F/SP 4MP 42X DarkFighter IR Network Speed

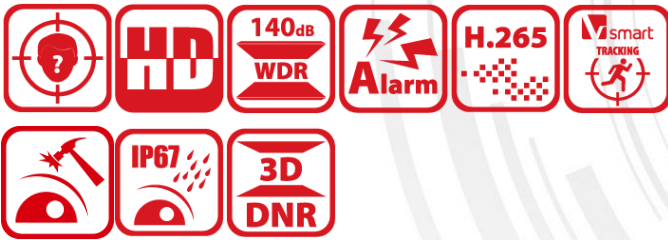

- 1/1.8" Progressive Scan CMOS
- High quality imaging with 4 MP resolution
- Excellent low-light performance with DarkFighter technology
- 42× optical zoom and 16× digital zoom provide close up views over expansive areas
- Expansive night view with up to 500 m IR distance
- Water and dust resistant (IP67) and vandal proof (IK10)
- Supports face capture to detect, capture, grade, and select faces in motion
- Supports road traffic to detect vehicles
- Smart Pan-Tilt Correction

▪ Specification

| Camera | |
|------------------------|---|
| Image Sensor | 1/1.8" progressive scan CMOS |
| Min. Illumination | Color: 0.001 Lux @ (F1.2, AGC ON), B/W: 0.0005 Lux @ (F1.2 , AGC ON), 0 Lux with IR |
| Shutter Speed | 1/1 s to 1/30,000 s |
| Slow Shutter | Yes |
| Day & Night | IR cut filter |
| Zoom | 42x optical, 16x digital |
| Max. Resolution | 2560 × 1440 |
| Lens | |
| Focus | Auto, semi-auto, manual, rapid focus |
| Focal Length | 6.0 mm to 252 mm |
| Zoom Speed | Approx. 4.5 s |
| FOV | Horizontal field of view: 56.6° to 1.7° (wide-tele), Vertical field of view: 33.7° to 0.9° (wide-tele), Diagonal field of view: 63.4° to 1.9° (wide-tele) |
| Aperture | Max. F1.2 |
| Illuminator | |
| Supplement Light Type | IR |
| Supplement Light Range | 500 m |
| Smart Supplement Light | Yes |
| PTZ | |
| Movement Range (Pan) | 360° |
| Movement Range (Tilt) | -20° to 90° (auto flip) |
| Pan Speed | Pan speed: configurable from 0.1° to 210°/s; preset speed: 280°/s |
| Tilt Speed | Tilt speed: configurable from 0.1° to 150°/s, preset speed 250°/s |
| Proportional Pan | Yes |
| Presets | 300 |
| Patrol Scan | 8 patrols, up to 32 presets for each patrol |
| Pattern Scan | 4 pattern scans, record time over 10 minutes for each scan |
| Power-off Memory | Yes |
| Park Action | Preset, pattern scan, patrol scan, auto scan, tilt scan, random scan, frame scan, panorama scan |
| 3D Positioning | Yes |
| PTZ Status Display | Yes |
| Preset Freezing | Yes |
| Scheduled Task | Preset, pattern scan, patrol scan, auto scan, tilt scan, random scan, frame scan, panorama scan, dome reboot, dome adjust, aux output |
| Video | |
| Main Stream | 50 Hz: 25 fps (2560 × 1440, 1920 × 1080, 1280 × 960, 1280 × 720) 60 Hz: 30 fps (2560 × 1440, 1920 × 1080, 1280 × 960, 1280 × 720) |
| Sub-Stream | 50 Hz: 25 fps (704 × 576, 640 × 480, 352 × 288) 60 Hz: 30 fps (704 × 480, 640 × 480, 352 × 240) |

| | |
|-----------------------------|--|
| Third Stream | 50 Hz: 25 fps (1920 × 1080, 1280 × 960, 1280 × 720, 704 × 576, 640 × 480, 352 × 288) 60 Hz: 30 fps (1920 × 1080, 1280 × 960, 1280 × 720, 704 × 480, 640 × 480, 352 × 240) |
| Video Compression | Main stream: H.265+/H.265/H.264+/H.264 Sub-stream: H.265/H.264/MJPEG Third stream: H.265/H.264/MJPEG |
| Video Bit Rate | 32 Kbps to 16384 Kbps |
| H.264 Type | Baseline Profile/Main Profile/High Profile |
| H.265 Type | Main Profile |
| Scalable Video Coding (SVC) | H.264 and H.265 encoding |
| Region of Interest (ROI) | 8 fixed regions for each stream |
| Audio | |
| Audio Compression | G.711alaw, G.711ulaw, G.722.1, G.726, MP2L2, PCM |
| Audio Bit Rate | 64 Kbps (G.711)/16 Kbps (G.722.1)/16 Kbps (G.726)/32 to 192 Kbps (MP2L2) |
| Network | |
| Network Storage | NAS (NFS, SMB/ CIFS), ANR |
| Protocols | IPv4/IPv6, HTTP, HTTPS, 802.1x, Qos, FTP, SMTP, UPnP, SNMP, DNS, DDNS, NTP, RTSP, RTCP, RTP, TCP/IP, DHCP, PPPoE, UDP, IGMP, ICMP, Bonjour |
| API | ISUP, ISAPI, Hikvision SDK, Open Network Video Interface (Profile S, Profile G, Profile T) |
| Simultaneous Live View | Up to 20 channels |
| User/Host | Up to 32 users. 3 levels: Administrator, Operator and User |
| Security | Password protection, complicated password, HTTPS encryption, 802.1X authentication (EAP-TLS, EAP-LEAP, EAP-MD5), watermark, IP address filter, basic and digest authentication for HTTP/HTTPS, RTP/RTSP over HTTPS, control timeout settings, security audit log, TLS 1.3, host authentication (MAC address) |
| Client | HikCentral, iVMS-4200, Hik-Connect |
| Web Browser | IE11, Chrome 57.0+, Firefox 52.0+, Safari 11+ |
| Image | |
| Image Settings | Saturation, brightness, contrast, sharpness, gain, and white balance adjustable by client software or web browser |
| Day/Night Switch | Day, night, auto, scheduled-switch |
| Image Enhancement | BLC, HLC, 3D DNR |
| Wide Dynamic Range (WDR) | 140 dB WDR |
| Defog | Optical defog |
| Image Stabilization | Yes. Built-in gyroscope to improve EIS performance. |
| Regional Exposure | Yes |
| Regional Focus | Yes |
| Privacy Mask | Up to 24 masks, polygon region, mosaic mask, mask color configurable |
| SNR | ≥ 52 dB |
| Supplement Detection | |
| Satellite Positioning | Yes |
| Compass | Yes |
| Interface | |
| Ethernet Interface | 1 RJ45 10M/100M self-adaptive Ethernet port |
| Fiber Optical | FC interface, built-in fiber module (100 M, TX1310/RX1550nm wavelength, single module fiber, up to 20 km transmission distance) |
| On-board Storage | Built-in memory card slot, support MicroSD/MicroSDHC/MicroSDXC, up to 256 GB |

| | |
|---|---|
| Alarm | 7 inputs, 2 outputs |
| Audio | 1 input (line in), max. input amplitude: 0-3.3Vpp, input impedance: 4.7KΩ±5%; 1 output (line out), line level, output impedance: 600 Ω |
| Video Output | 1.0V[p-p]/75Ω, PAL, NTSC, BNC connector |
| RS-485 | HIKVISION, Pelco-P, Pelco-D, self-adaptive |
| Event | |
| Basic Event | Motion detection, video tampering alarm, alarm input and output, exception |
| Smart Event | Line crossing detection, region entrance detection, unattended baggage detection, object removal detection, intrusion detection, region exiting detection, vandal-proof alarm, audio exception detection |
| Smart Tracking | Manual tracking, auto-tracking |
| Alarm Linkage | Alarm actions, such as Preset, Patrol Scan, Pattern Scan, Memory Card Video Record, Trigger Recording, Notify Surveillance Center, Upload to FTP/Memory Card/NAS, Send Email, etc. |
| Deep Learning Function | |
| Face Capture | Support detecting up to 30 faces at the same time. Support detecting, tracking, capturing, grading, selecting of face in motion, and output the best face picture of the face |
| Face Comparison | Yes |
| Perimeter Protection | Line crossing, intrusion, region entrance, region exiting Support alarm triggering by specified target types (human and vehicle) |
| Road Traffic and Vehicle Detection | |
| Road Traffic | Support vehicle detection (license plate number, vehicle model, and vehicle color recognition) |
| General | |
| General Function | Mirror, password protection, watermark, IP address filter |
| Power | 24 VAC (Max. 60 W, including max. 18 W for IR and max. 6 W for heater) |
| Operating Condition | Temperature: -40°C to 70°C (-40°F to 158°F), Humidity: ≤ 95% |
| Dimension | ∅ 267 mm × 405 mm (∅ 10.51" × 15.94") |
| Weight | Approx. 8.5 kg (18.74 lb.) |
| Language | 33 languages: English, Russian, Estonian, Bulgarian, Hungarian, Greek, German, Italian, Czech, Slovak, French, Polish, Dutch, Portuguese, Spanish, Romanian, Danish, Swedish, Norwegian, Finnish, Croatian, Slovenian, Serbian, Turkish, Korean, Traditional Chinese, Thai, Vietnamese, Japanese, Latvian, Lithuanian, Portuguese (Brazil), Ukrainian |
| Approval | |
| EMC | FCC SDoC (47 CFR Part 15, Subpart B); CE-EMC (EN 55032: 2015, EN 61000-3-2: 2019, EN 61000-3-3: 2013, EN 50130-4: 2011 +A1: 2014); RCM (AS/NZS CISPR 32: 2015); IC VoC (ICES-003: Issue 6, 2019); KC (KN 32: 2015, KN 35: 2015) |
| Safety | UL (UL 62368-1) CB (IEC 60950-1:2005 + Am 1:2009 + Am 2:2013, IEC 62368-1:2014); CE-LVD (EN 62368-1:2014+A11:2017), BIS (IS 13252(Part 1):2010+A1:2013+A2:2015); LOA (SANS IEC60950-1) |

| | |
|-------------|--|
| Environment | CE-RoHS (2011/65/EU); WEEE (2012/19/EU); Reach (Regulation (EC) No 1907/2006) |
| Protection | IP67 Standard, Lightning Protection, Surge Protection and Voltage Transient Protection, ±6kV Line to Gnd, ±3kV Line to Line, IEC61000-4-5, IK10 |

▪ **Available Model**

DS-2DF8A442IXG-F/SP



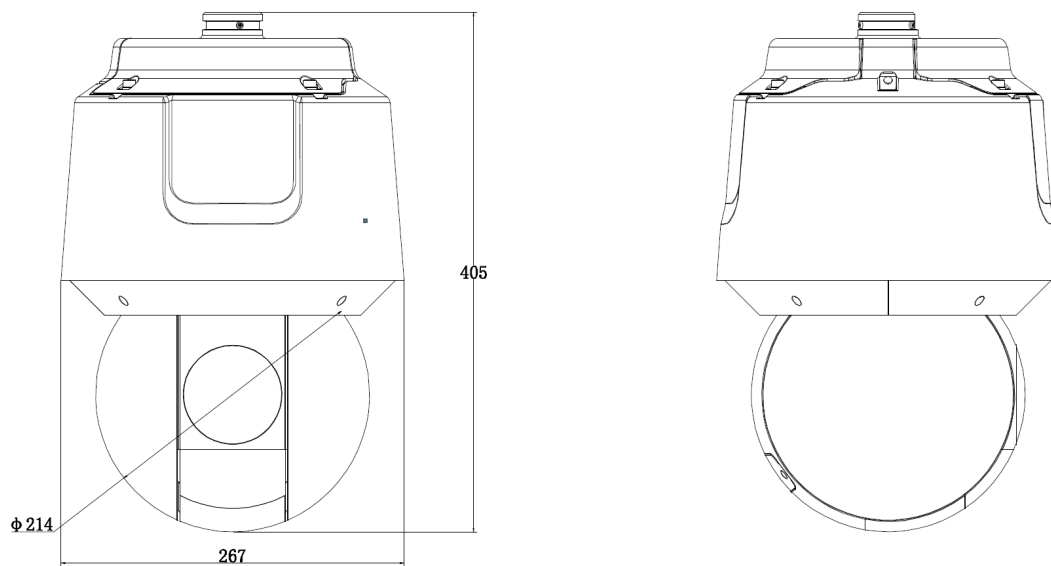











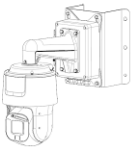

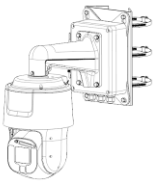
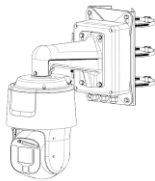

▪ **Dimension**

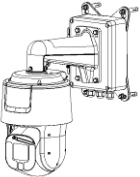
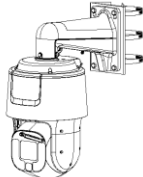
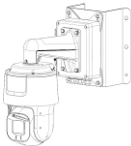

Accessory

▪ **Optional**

| DS-1660ZJ-P Wall mount | DS-1604ZJ-Corner-P Corner mount | DS-1673ZJ-P Vertical pole mount | DS-1604ZJ-P Wall mount | DS-1604ZJ-Pole-P Vertical pole mount |
|---------------------------|------------------------------------|------------------------------------|---------------------------|---|
| | | | | |
| | | | | |

| DS-4660ZJ-PC | DS-1673ZJ-P Vertical pole mount | DS-1604ZJ-BOX-PO LE-P Vertical pole mount | DS-4650ZJ-PC | DS-1662ZJ-P Pendant Mount |
|---|---|---|---|---|
|  |  |  |  |  |
|  |  |  |  |  |
| DS-1674ZJ-P | DS-1684ZJ-P | DS-1604ZJ-BOX-CO RNER-P Wall mount | DS-1663ZJ-P In-ceiling mount | DS-1673ZJ-P Vertical pole mount |
|  |  |  |  |  |
|  |  |  |  |  |
| DS-1604ZJ-BOX-P Wall mount | DS-1661ZJ-P Pendant Mount | DS-1667ZJ-P Pendant Mount | DS-1602ZJ-P Wall Mount | |
|  |  |  |  | |

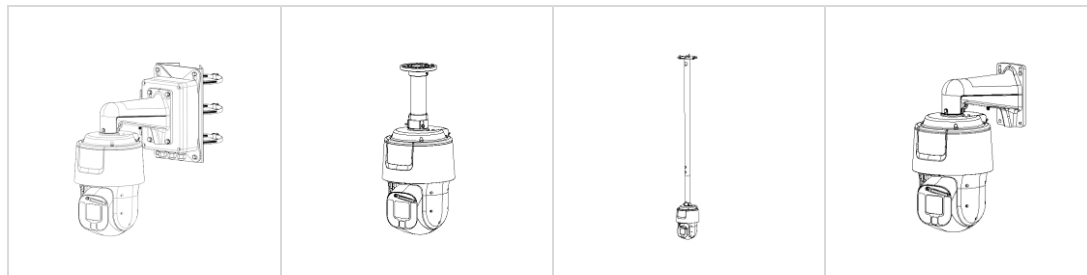

Headquarters

No.555 Qianmo Road, Binjiang District,
Hangzhou 310051, China
T +86-571-8807-5998
www.hikvision.com



Follow us on social media to get the latest product and solution information.

